

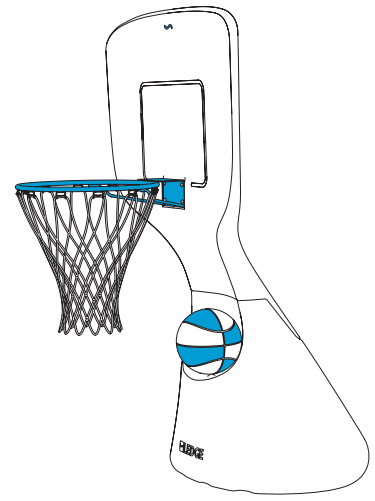

ASSEMBLY GUIDE FOR HOOPSTR



IMPORTANT NOTE

CAREFULLY READ ALL INSTRUCTIONS BEFORE STARTING. ENSURE THERE IS A WATER HOSE NEARBY FOR FILLING OF PRODUCT. CRITICAL STEPS MIGHT BE MISSED RESULTING IN UNSUCCESSFUL ASSEMBLY OR DAMAGE TO THE PRODUCT.

2 PERSON ASSEMBLY RECOMMENDED.

CONTENTS

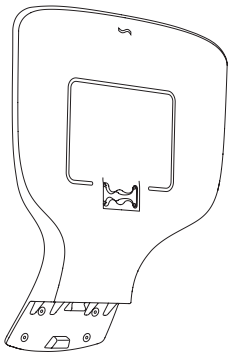

x1 Backboard

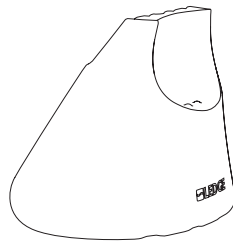

x1 Base

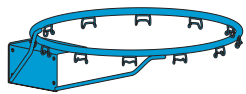

x1 Rim

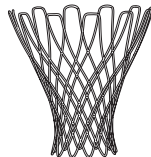

x1 Net



x1 Ball



x5 Screw A*



x5 Screw B*



x10 Flat Washer*



x10 Lock Washer*



x5 Acorn Nut*



x1 Allen Wrench

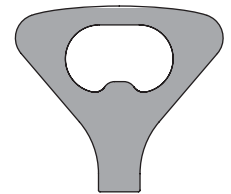

x1 Plug Key

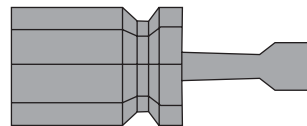

x1 Nut Driver



x1 Ball Pump



x1 Fill Plug**



x1 Drain Plug**

* Extra Hardware Included

** Installed in Base

STEP 1: Join the backboard to the base.

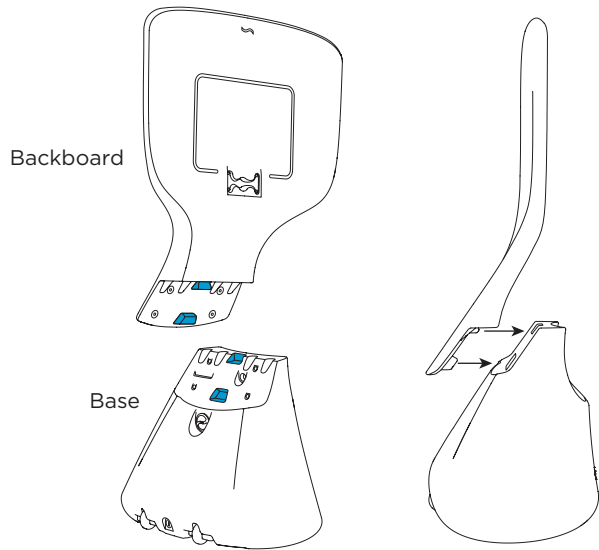

STEP 2: Ensure the seam doesn't have gaps. If there are gaps, hit the area between the 4 screw holes with the palm of your hand to properly join the two parts.

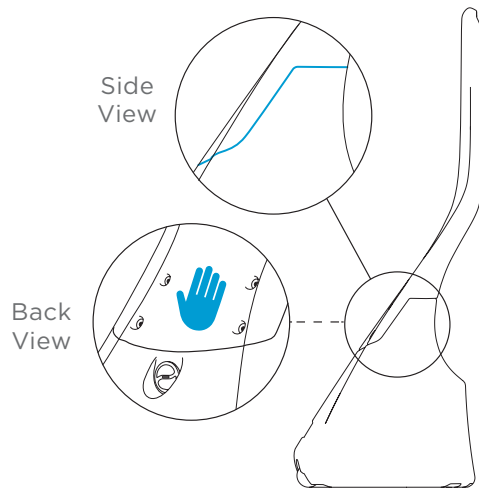

STEP 3: Set up 4 screws (A) with a lock washer and a flat washer. Have allen wrench readily available.

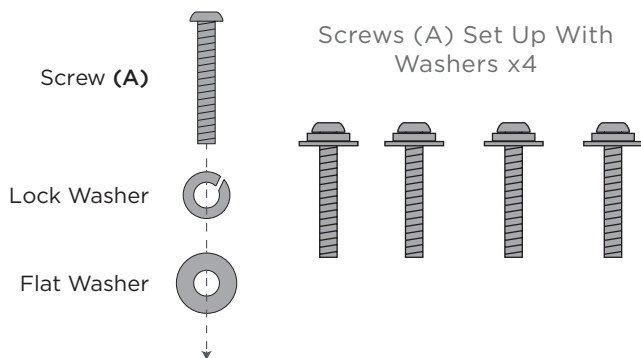

STEP 4: Hand tighten the 4 screws with washers, in the following order. Do not fully tighten until all 4 screws are started. Tighten to secure backboard to base.

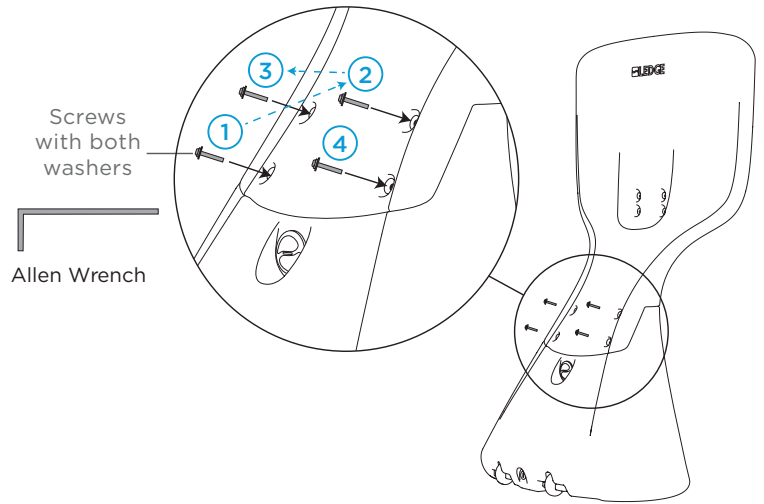

STEP 5: Insert one screw (B) into one of the top holes of the rim.

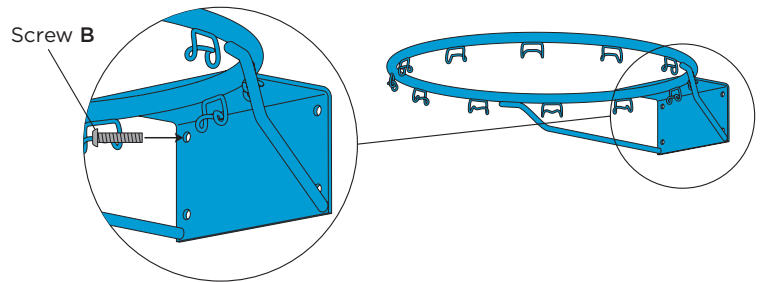

STEP 6: Position the rim with the first screw in the front of the backboard as shown. Have flat washers, lock washers, and acorn nuts readily available.

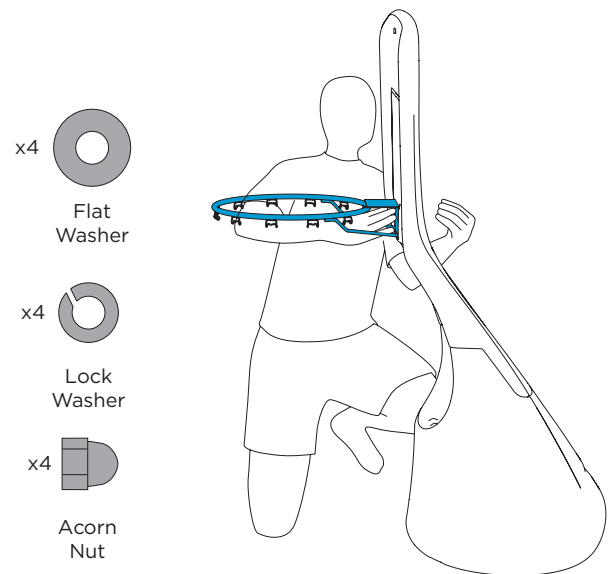

STEP 7: While holding the screw and the rim with one hand, insert flat washer, and lock washer from the back of the unit, then hand tighten the acorn nut.

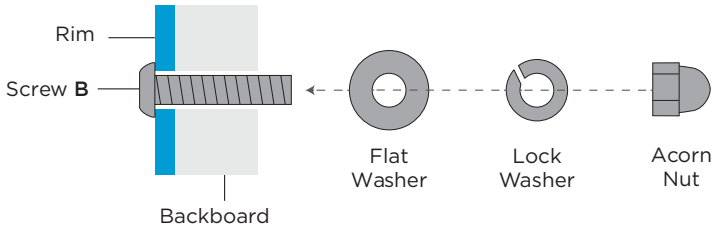

STEP 8: Insert 3 screws (B) into remaining rim holes and repeat Step 7. Using the allen wrench to hold the screws in place, tighten the acorn nuts with the nut driver.

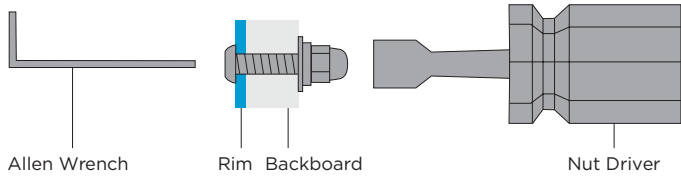
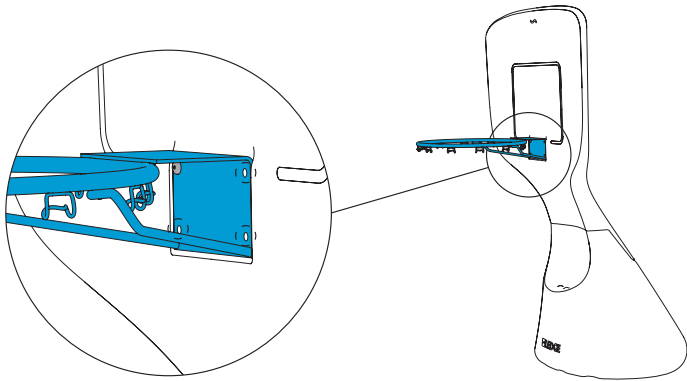

STEP 9: Determine the final location for your new Hoopstr. Gently tilt back to engage wheels. Exercise caution when tilting and setting the unit back down.

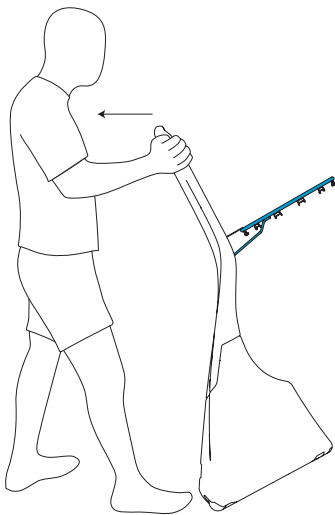

STEP 10: Unscrew the fill plug. Use the plug key if necessary.

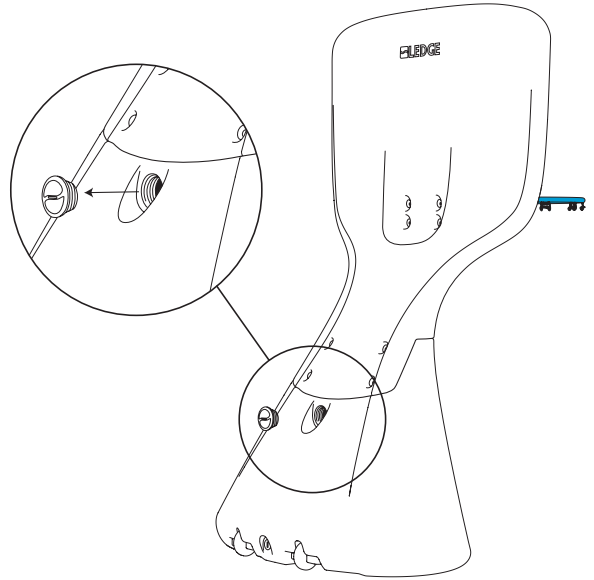

STEP 11: Fill the base until it overflows. Then, reinstall the fill plug.

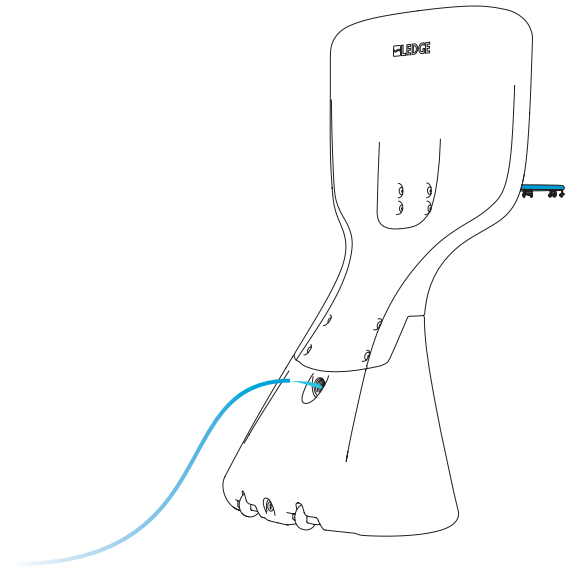

STEP 12: Loop the net, starting with the wider end of the net.

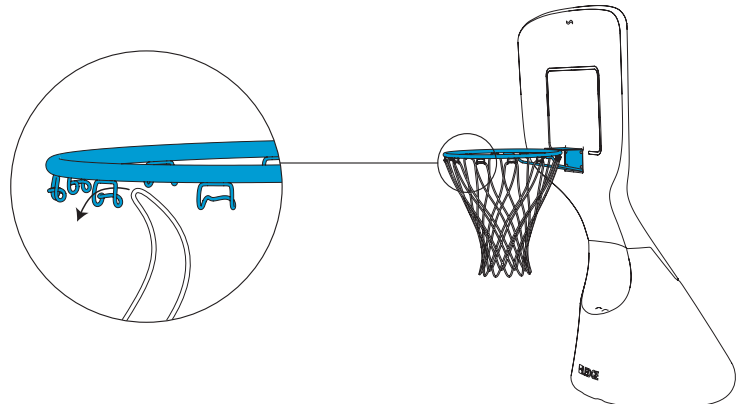

STEP 13: Install the pump needle, found in the pump handle. Then, inflate the basketball with the pump.

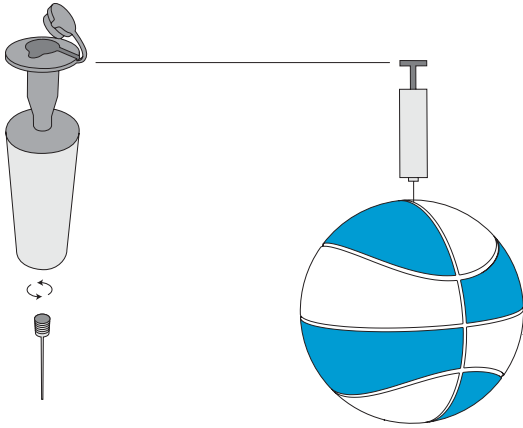

DRAINING

Unscrew the drain plug using the plug key, which also doubles as a bottle opener.

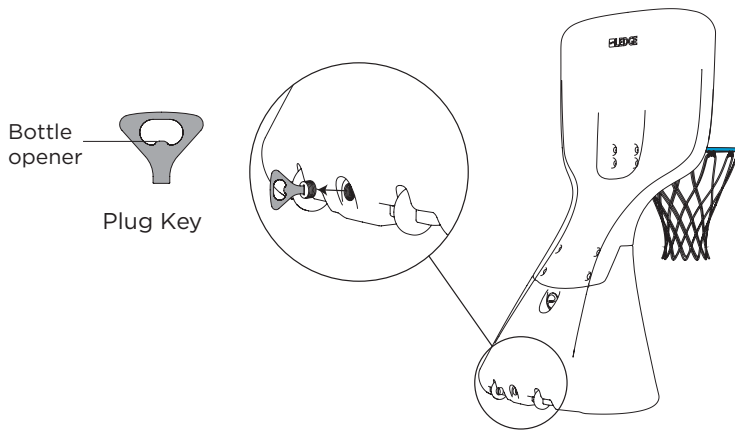

BALL STORAGE

To maximize ball longevity, take the ball out of the pool and place it in the ball holder for convenient storage.

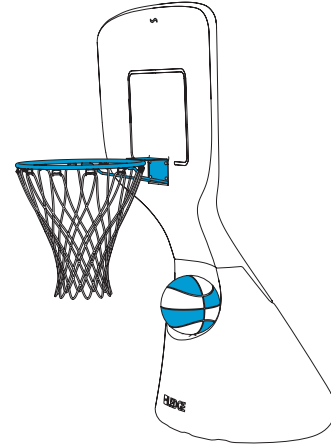

ROUTINE CLEANING

For routine cleaning, use water and a soft cloth or microfiber towel. For stubborn stains, use mild soap and water with a soft bristle brush.

Should unit require touch up to powder coated rim, please reach out to our customer service team at 888.749.5336.

SHARE YOUR MEANINGFUL MOMENTS WITH US

#LEDGELIFE