

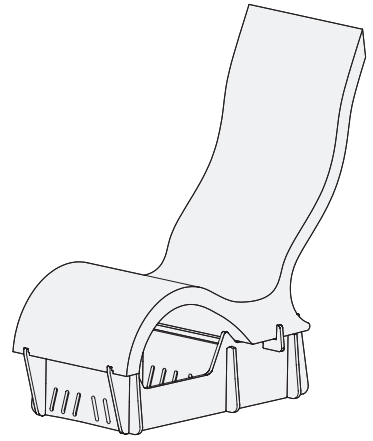

# ASSEMBLY GUIDE FOR SIGNATURE CHAIR RISER



## CONTENTS



TOP CROSSBAR

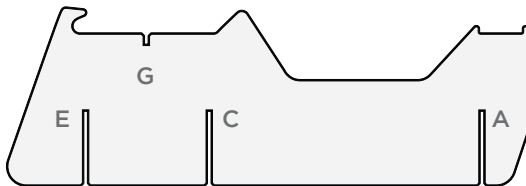

LEFT SIDEBAR

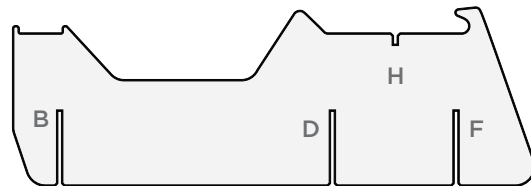

RIGHT SIDEBAR

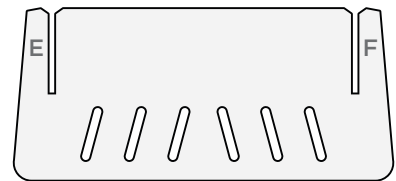
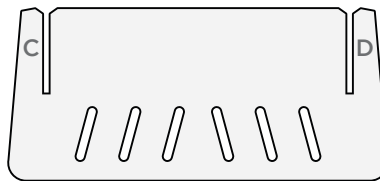
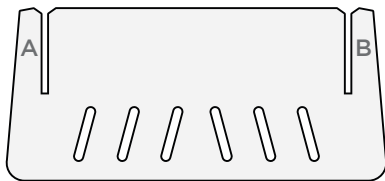

BOTTOM CROSSBARS

## LETTER MATCHING SYSTEM

Look for an engraved letter near each slot on the enclosed riser pieces. Always match up coordinating slots (A+A, B+B, etc.) to ensure proper assembly.

**Before you begin** ensure your Chair is properly filled with water according to the Chair installation instructions received with your original shipment. Lost your installation instructions? Contact us at [info@ledgeloungers.com](mailto:info@ledgeloungers.com)

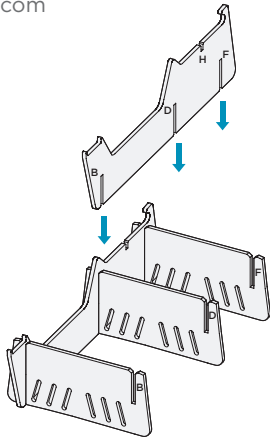

### STEP 1: ASSEMBLE RISER BASE

Align the matching slots of the sidebars and bottom crossbars and slide the pieces together. Continue until all 5 pieces of the base are assembled as shown above. The side with the letter engraving should face outward.

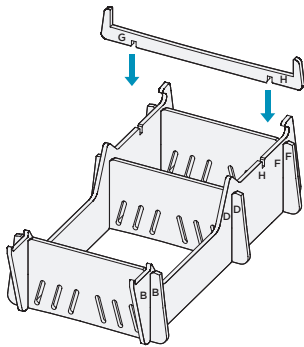

### STEP 2: INSERT TOP CROSSBAR

Align and insert the matching slots of the top crossbar with the remaining upward facing slots of the base.

### STEP 3: SECURE RISER PIECES

Ensure all pieces are secured by pushing each slot until the pieces are flush with one another. Some movement is okay and will even out once assembly is complete.

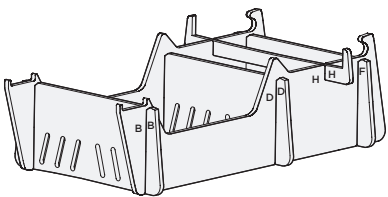

### STEP 4: INSTALL RISER

Carefully pick up the riser and place on your pool's ledge in the desired location of your Chair. The "hooks" of the riser are the back of the riser system.

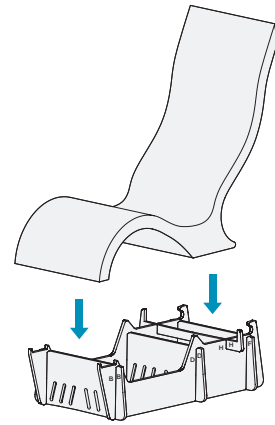

### STEP 5: INSTALL CHAIR ON RISER

Lift the Chair and position on the riser. We recommend using two people for this step.

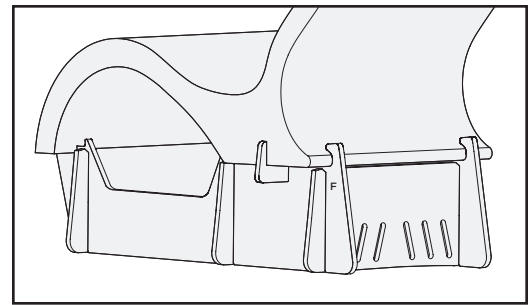

properly secured riser and Chair

### STEP 6: FINAL INSTALLATION

Visually check that the Chair is centered. The front, back, and sides of the Chair should be inside the hooks of the riser.

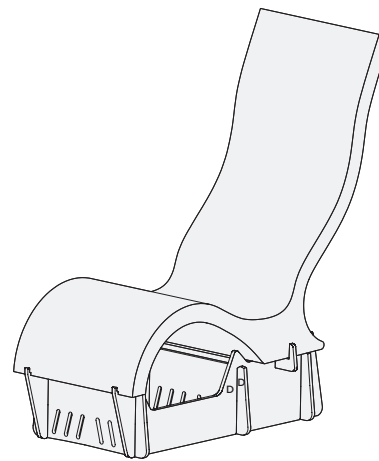

**Sit back and relax!** Take a photo, share it on social media, and tag

**#LEDGELIFE**