

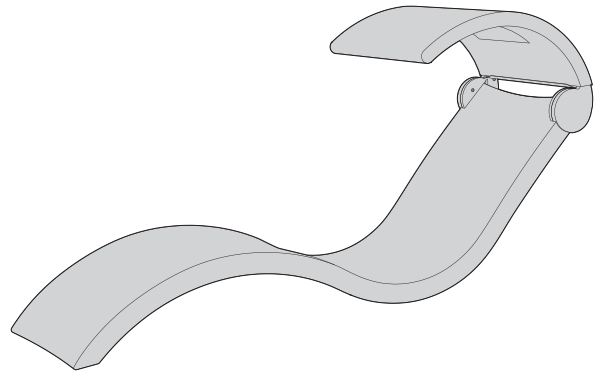

# ASSEMBLY GUIDE FOR SIGNATURE CHAISE & CHAIR SHADE



## IMPORTANT NOTE

No tools required for assembly.

**STEP 1:** Set one side frame piece down with holes facing up.

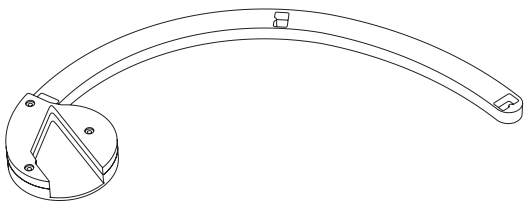

**STEP 2:** Match holes of the frame piece with tabs of the middle crossbars, inserting the 3 middle crossbar pieces into the side frame piece, and apply pressure to lock them together.

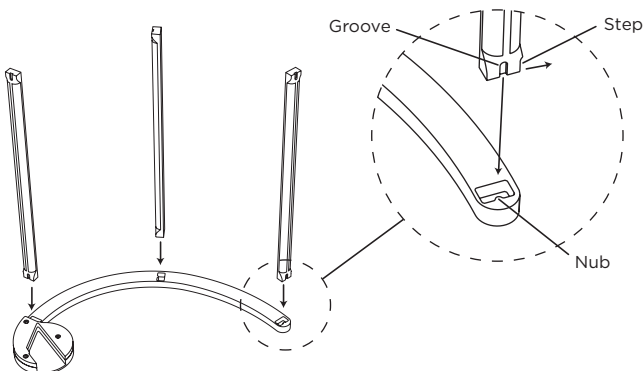

**STEP 3:** Set the second frame piece on top, repeating the process of inserting the tabs into the holes, and apply pressure to lock them together.

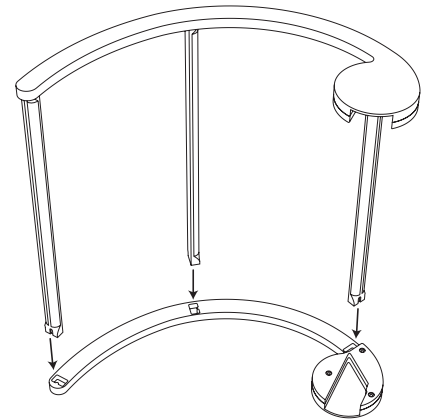

**STEP 4:** Slip fabric on to the frame with the clear media viewing window facing the inside of the curve, or the bottom of the shade. Close velcro flap.

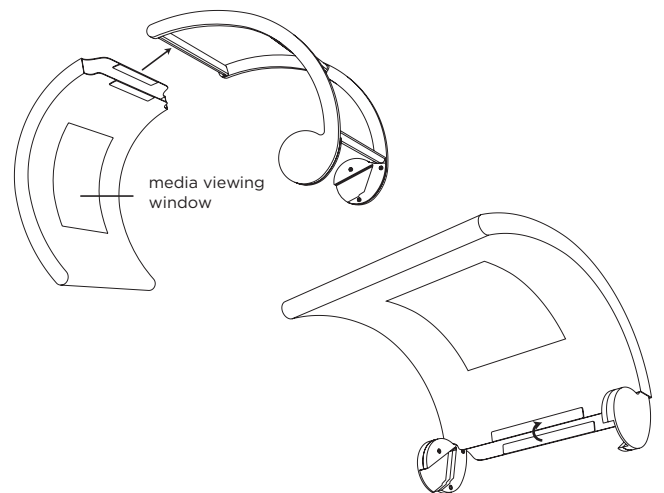

**STEP 5:** Slide frame on to the back of seat. In some cases there's a gap between the seat and shade, this is normal as long as shade feels secure.

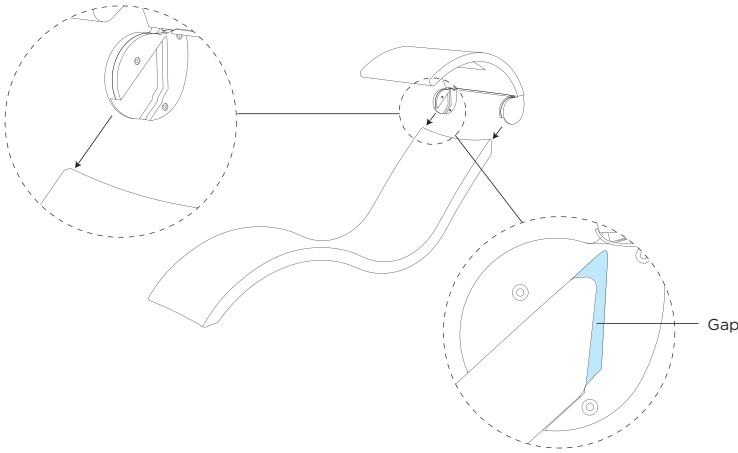

**STEP 6:** You're all done, enjoy your new product and begin creating life's most meaningful moments.

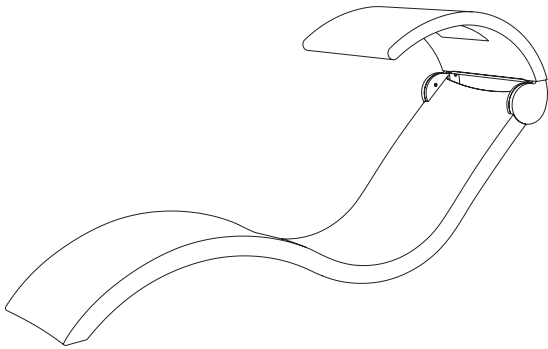

## ROUTINE CLEANING

For routine cleaning, just use water and a soft cloth or microfiber towel, or spray down with a water hose. For a deeper clean, use mild soap and water and a soft bristle brush.

## POWER WASHING

If power washing is desired, start with a low PSI, at least 3 ft away from furniture. Move closer or increase PSI gradually and with caution. While power washing, check often to ensure no inscription is left on the surface.

For more information on cleaning & care, please visit [ledgeloungers.com/faq](http://ledgeloungers.com/faq)

SHARE YOUR MEANINGFUL MOMENTS WITH US

**#LEDGELIFE**