

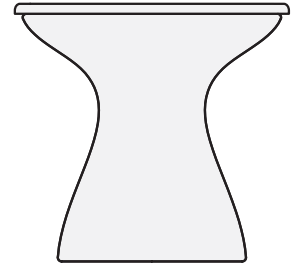

AUTOGRAPH STANDARD SIDE TABLE



THANK YOU FOR YOUR PURCHASE

Our team of expert designers, craftsmen, and pool industry professionals have obsessed over every detail of your Autograph Standard Side Table. From concept to delivery, every decision was made with you in mind. Sweating the smallest things is our goal, so you can enjoy the big things that matter - making meaningful moments.

Your outdoor experience comes with peace of mind. That's why we pride ourselves on long-lasting, low-maintenance outdoor living, and we back it up with a best-in-class warranty.

If you aren't happy with your purchase, please give us a call at 888.749.5336. We will do whatever it takes to make it right.

BEFORE YOU START

For fun and effective setup, prepare to get wet. Throw on your bathing suit, gather your setup materials and jump in!

IMPORTANT NOTE

The Autograph Standard Side Table is designed for water depths up to 12" or on-deck.

REQUIRED TOOLS



FLATHEAD SCREWDRIVER

YOUR POOL

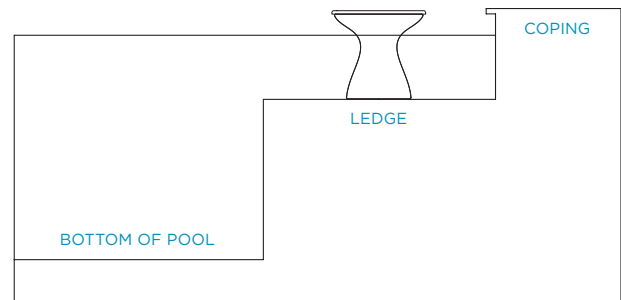

STEP 1: Place the Autograph Standard Side Table upside down in the shallow-end of your pool. Remove plugs from both fill holes on the bottom of the table with a flat head screw driver.

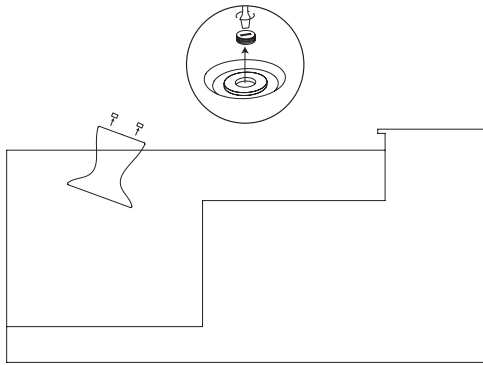

STEP 2: Submerge one fill hole first and allow water to start filling the table. You will hear the cavity filling from the other fill hole.

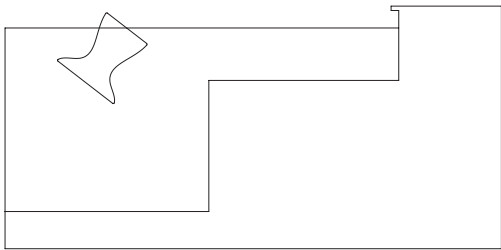

STEP 3: Allow the table to submerge. Water will enter quickly. Once the entire table is filled, rock it several times front to back to release any remaining air.

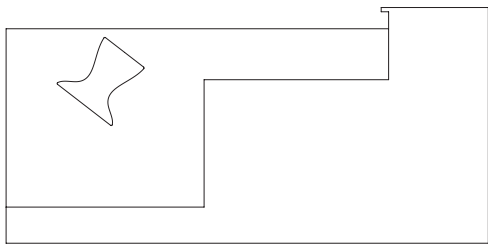

STEP 4: Keep the table submerged and screw the plugs back in. Handle plugs carefully to avoid cross-threading them.

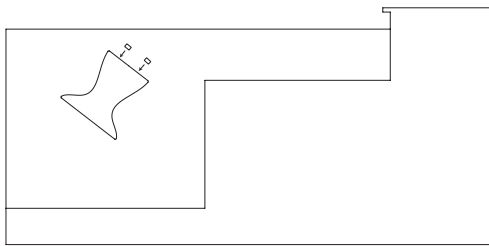

STEP 5: Turn the Autograph Standard Side Table right side up and position the base on edge of the ledge. Carefully slide it into its final location.

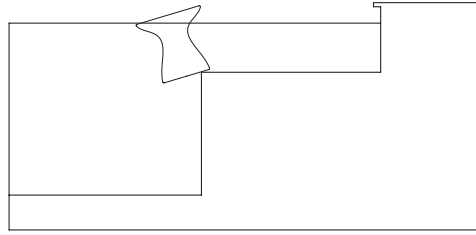

STEP 6: Place the lid onto the stand.

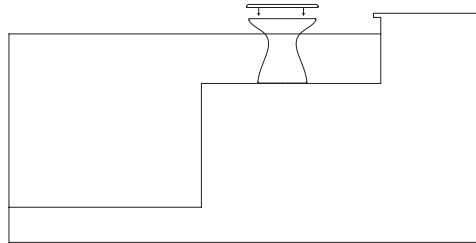

STEP 7: Enjoy your new Autograph Standard Side Table and begin creating life's most meaningful moments. Tag us for a chance to be featured!

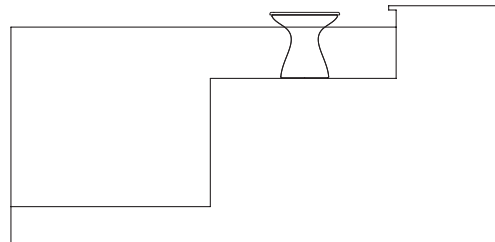

CARE AND MAINTENANCE

ROUTINE CLEANING

Clean with a soft cloth, microfiber towel, or spray down with a water hose. For a deeper clean, use mild soap and water with a soft bristle brush.

POWER WASHING

Use caution to avoid etching your Autograph Standard Side Table. Start with a very low PSI at least 3 feet away from furniture, and test on the under side before moving closer. Move closer or increase PSI gradually and with caution until dirt is removed. Check often to ensure no etching is left on furniture.

SHOW US HOW YOU LIVE THE LEDGE LIFE

#LEDGELIFE